

Bagageluien

Standaard

- / Robuuste constructie met aluminium kader en gelaste hoeken
- / Buitenkader en luik deur poedergecoat in RAL 9016 wit (de coating is overspuitbaar)
- / Ontwerp met thermische scheiding en robuuste afdichting
- / Geschikt voor wanddikte 45-90mm
- / Eén of twee gasveren afhankelijk van de afmeting van het luik
- / Te openen tot een maximale hoek van 120°
- / Vlak geïntegreerde roestrijstalen handgreep
- / Roestrijstalen pianoscharnier
- / Slot cilinder met certificaat, kan ook gelijksluitend geleverd worden
- / Roestrijstalen regengoot



Luiken afmetingen

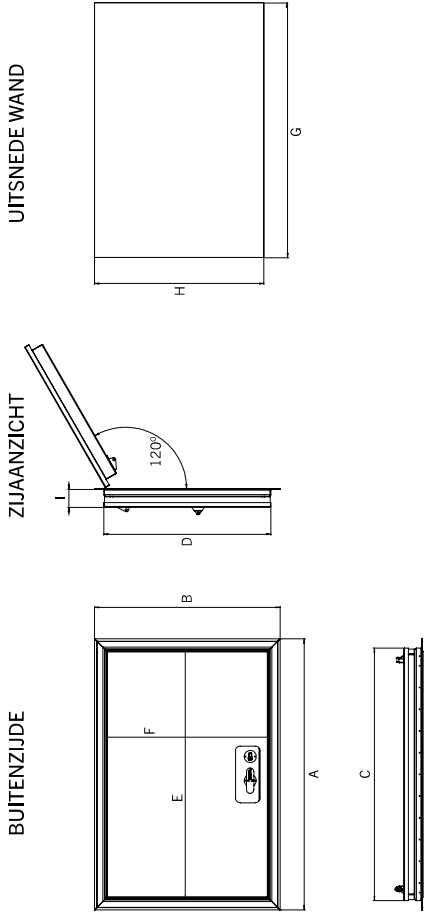

Luiken afmetingen

TYPE NUMMER	BUITEN AFMETING		BINNEN AFMETING			LICHT MAAT			UITSNEDE WAND			DIKTE	GEWICHT
	A	B	C	D	E	F	G	H	I				
STANDAARD LUIKEN													
K4050	473	573	396	496	330	430	405	505	75	7,40			
K5040	573	473	496	396	430	330	505	405	75	7,40			
K6050	673	573	596	496	530	430	605	505	75	11,00			
K6580	723	873	646	796	580	730	655	805	75	17,10			
K5767	643	743	566	666	500	600	575	675	75	11,10			
K7767	843	743	766	666	700	600	775	675	75	15,50			
K8767	943	743	866	666	800	600	875	675	75	17,80			
K12767	1343	743	1266	666	1200	600	1275	675	75	26,70			
K8085	873	923	796	846	730	730	805	855	75	16,80			
K8565	923	723	846	646	780	580	855	655	75	16,00			
K8580	923	873	846	796	780	730	855	805	75	16,80			
K9045	973	523	896	446	830	380	905	455	75	9,30			
K95105	1023	1123	946	1046	880	980	955	1055	75	23,00			
K10080	1073	873	996	796	930	730	1005	805	75	18,50			
K10545	1123	523	1046	446	980	380	1055	455	75	10,90			
K10570	1123	773	1046	696	980	640	1055	705	75	16,40			
K105105	1123	1123	1046	1046	980	980	1055	1055	75	24,60			
K105125	1123	1323	1046	1246	980	1180	1055	1255	75	29,30			
K11595	1223	1023	1146	946	1080	880	1155	955	75	22,60			
K125105	1323	1123	1246	1046	1180	980	1255	1055	75	25,40			
K135145-2P*	1423	1523	1346	1446	1280	1380	1355	1455	75	36,50			
K14570-2P*	1523	773	1446	696	1380	630	1455	705	75	19,20			
K14595-2P*	1523	1023	1446	946	1380	880	1455	955	75	27,00			
K145135-2P*	1523	1423	1446	1346	1380	1280	1455	1355	75	26,80			

*2p = 2 handgrepen en 2-punts vergrendeling

LUIKEN met schuine randen

KS6060L 4343	673	673	596	596	530	530	605	605	75	12,30
KS6060R 4343	673	673	596	596	530	530	605	605	75	12,30
KS7646L 2020	833	533	756	456	690	390	765	465	75	8,50
KS7646R 2020	833	533	756	456	690	390	765	465	75	8,50
KS9090L 3535	973	973	896	896	830	830	905	905	75	18,40
KS9090R 3535	973	973	896	896	830	830	905	905	75	18,40
KS10570L 2020	1123	773	1046	696	980	630	1055	705	75	16,70
KS10570R 2020	1123	773	1046	696	980	630	1055	705	75	16,70
KS13570L 2020	1423	773	1346	746	1280	630	1355	755	75	22,00
KS13570R 2020	1423	773	1346	746	1280	630	1355	755	75	22,00
KS14070L-3535	1473	773	1396	696	1330	630	1405	705	75	23,00
KS14070R-3535	1473	773	1396	696	1330	630	1405	705	75	23,00

Luiken overzicht diverse modellen



Foto-impressie



Voorbeeld buitenzijde luik met schuine hoek

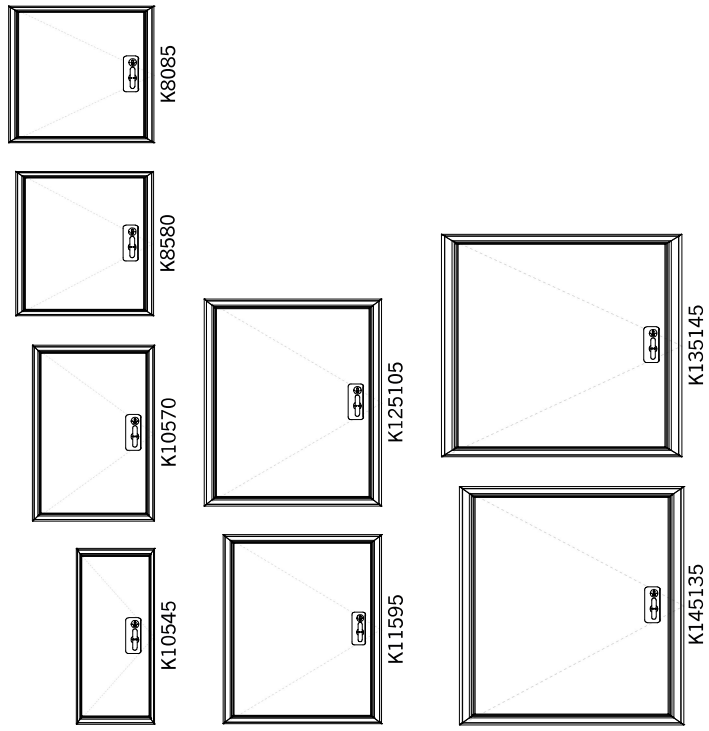

Verzonken handgreep met design roestvrijstalen handgreep



Detail buitenzijde luik



Details luiken



Standaard RVS regengoot



Afmetingen luiken met schuine hoeken

KS7646R

BUITENZIJDE

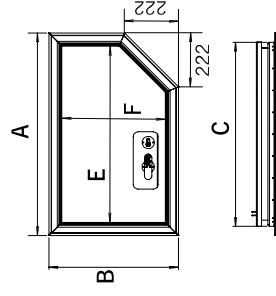

ZJAAANZICHT

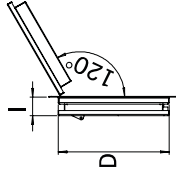

UITSNEDE WAND

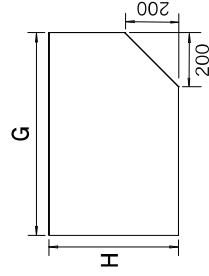

KS10570R

BUITENZIJDE

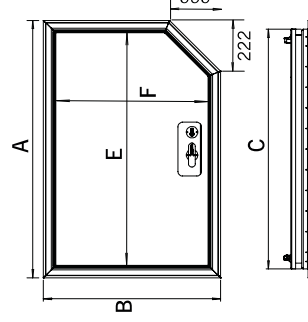

ZJAAANZICHT

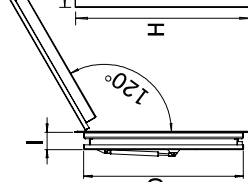

UITSNEDE WAND

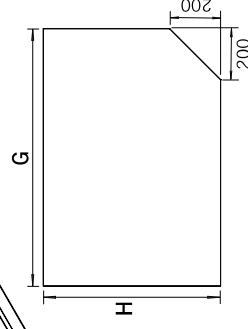

KS14070R

BUITENZIJDE

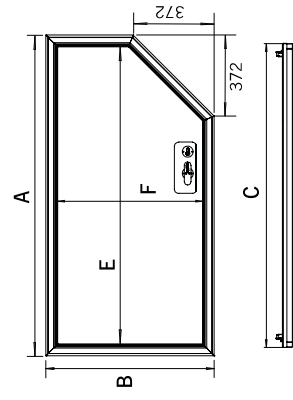

ZJAAANZICHT

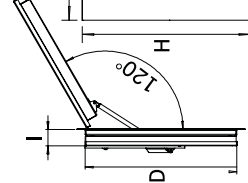

UITSNEDE WAND

