

Contents

	Page
Doors	5
// Photo impression	6
// Model overview	7
// Dimensions	8
// Installation possibilities (in various wall thicknesses)	9
Fly screen for doors	11
// Photo impression	12
// Dimensions	13
Windows	15
// Photo impression	16
// Model overview	17
// Dimensions	18
Double roller blinds	20
// Dimensions	21
Storage space hatches	23
// Hatch dimensions model overview	24
// Photo impression	26
// Dimensions of the hatches with inclines	27
// Hatch installation possibilities in various wall thicknesses	28
Access doors	30
// Photo impression	31
// Model overview	32
// Dimensions	33
Skylight roof hatches	35
// Photo impression	36
// Installation possibilities for roof hatches in various wall thicknesses	37
// Dimensions	38
Outview Panoramic hatches	40
// Dimensions	42
Maintenance hatches	44
Doors	
Standard	
// Robust construction with aluminium frame and welded corners	
// Powder-coated on all sides in RAL 9016 white (the coating can be repainted)	
// Door leaf with an aluminium construction (canted and welded); surface powder coated	
// Design with thermal separation and strong sealing	
// Low installation depth (wall thicknesses of 45-90mm can be achieved)	
// Opening angle maximum 180°	
// The locking cylinders can be delivered with simultaneous locking	
// Stainless steel design and low structure of the handles on the inside	
Options	
// Pleated fly screen can be delivered in white or anthracite	
// Doors with window	
// Doors with offset handle	

Photo impression



Installed door open

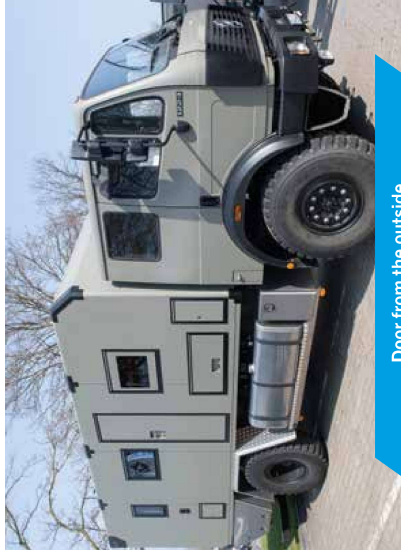

Door from the outside

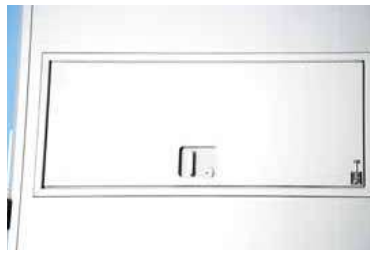

Installed door (in special colour)



Darkening fixed window



Stainless steel
Design handle and
cylinder
Flat recessed grip



Lock
inside



Door with fixed window

Model overview doors

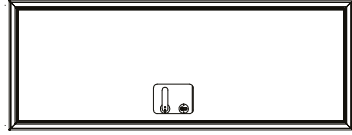

T62177R

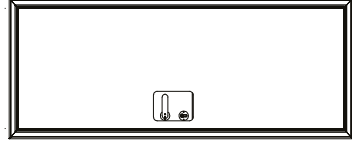

T68177R

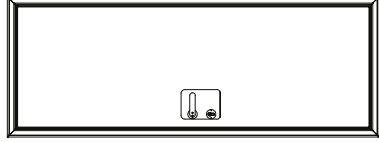

T68192R

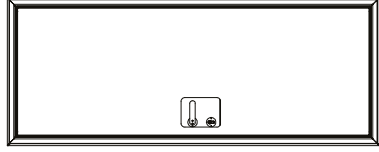

T72192R

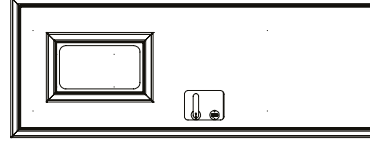

T68192R-FN



T68192R-TVG

This model
is only
available
with 2p
locking

Doors dimensions

DESIGNATION	DIMENSION OUTSIDE		DIMENSION INSIDE		CUTOUT WALL		CLEAR MEASUREMENT		THICK-NESS	HEIGHT HANDLE	WEIGHT
	A	B	C	D	E	F	G	H			
STANDARD DOORS											
T62177R*	693	1843	616	1766	625	1775	562	1712	75	1000	23,9
T68177R*	753	1843	676	1766	685	1775	622	1712	75	1000	26,2
T68192R*	753	1993	676	1916	685	1925	622	1862	75	1000	30,7
T72192R*	793	1993	716	1916	725	1925	662	1862	75	1000	32,5
* Can also be delivered with offset handle on 500mm											
DOORS WITH WINDOWS											
T62177R-F3050FN ¹	693	1843	616	1766	625	1775	562	1712	75	1000	32
T68192R-F3050FN ¹	753	1993	676	1916	685	1925	622	1862	75	1000	
T68177R-F3050 ²	753	1993	676	1766	685	1775	622	1712	75	1000	
T68177R-F3050FN	753	1993	676	1766	685	1775	622	1862	75	1000	

¹ FN=Fixed window

Installation possibilities for doors with various wall thicknesses

Installation of door in wall <60mm

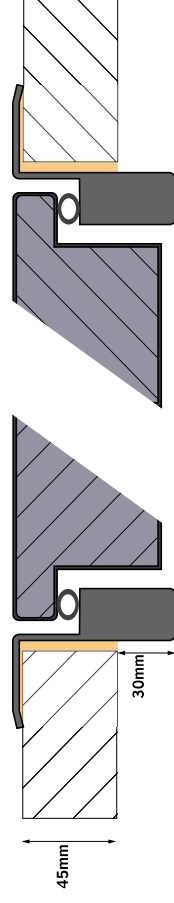

Installation of door in wall =60mm

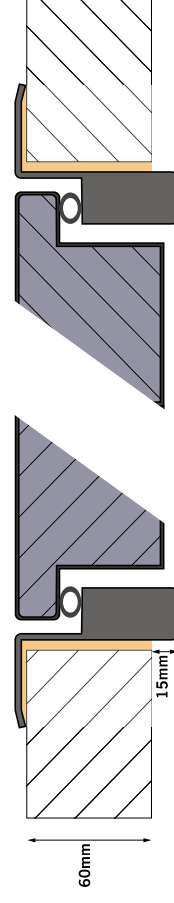

Installation of door in wall >60mm

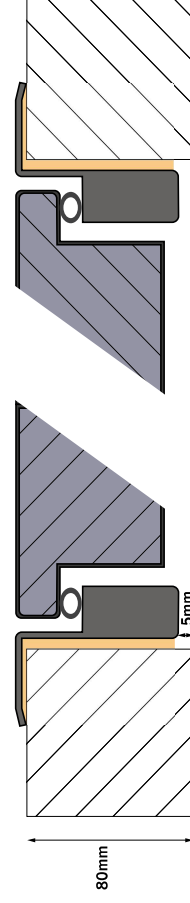

Doors dimensions

DESIGNATION	DIMENSION OUTSIDE		DIMENSION INSIDE		CUTOUT WALL		CLEAR MEASUREMENT		THICK-NESS	HEIGHT HANDLE	WEIGHT
	A	B	C	D	E	F	G	H			
STANDARD DOORS											
T62177R*	693	1843	616	1766	625	1775	562	1712	75	1000	23,9
T68177R*	753	1843	676	1766	685	1775	622	1712	75	1000	26,2
T68192R*	753	1993	676	1916	685	1925	622	1862	75	1000	30,7
T72192R*	793	1993	716	1916	725	1925	662	1862	75	1000	32,5
* Can also be delivered with offset handle on 500mm											
DOORS WITH WINDOWS											
T62177R-F3050FN ¹	693	1843	616	1766	625	1775	562	1712	75	1000	32
T68192R-F3050FN ¹	753	1993	676	1916	685	1925	622	1862	75	1000	
T68177R-F3050 ²	753	1993	676	1766	685	1775	622	1712	75	1000	
T68177R-F3050FN	753	1993	676	1766	685	1775	622	1862	75	1000	

¹ FN=Fixed window

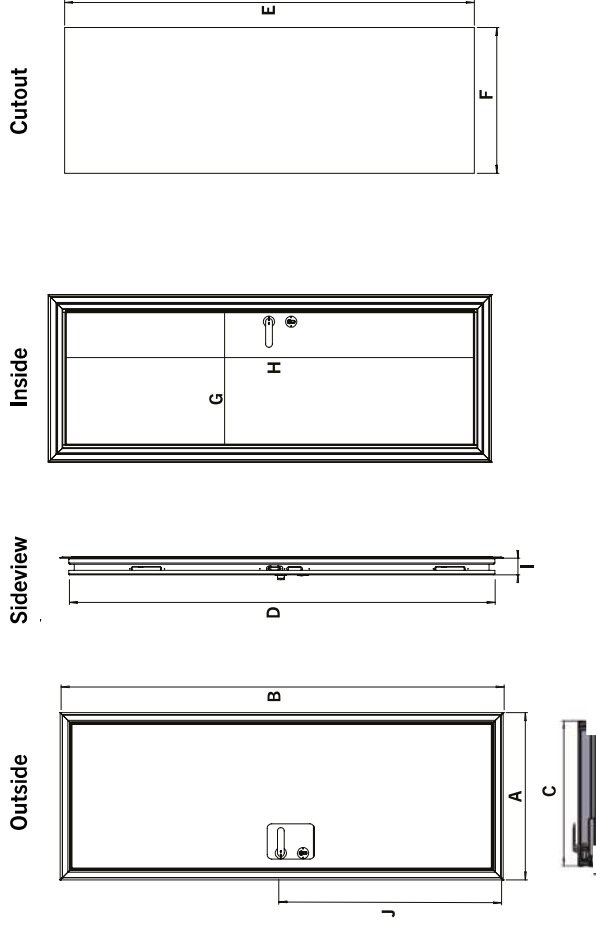



Fly screen for doors

Standard

- / Robust construction & functionality
- / Perfect combination with the WideBird® doors
- / Frame made of powder-coated aluminium
- / Standard color RAL9010 (white) or optionally in RAL 7016 (anthracite grey)
- / Fly screen made of black polypropylene (also dimensionally stable after years of intensive use)
- / Chain guide up and down (can also be easily inserted if needed)
- / Fly screen with low installation depth (ca. 40mm)

Photo impression



Fly screen from the inside



Guide bottom with magnetic rail



Guide bottom with magnetic rail RAL 7016



Fly screen frame RAL 7016

Dimensions fly screen for doors

DESIGNATION	DIMENSION OUTSIDE		WEIGH	
	A mm	B mm		I mm
STANDARD FLY SCREEN				
FG-T62177R/L-W	695	1792	40	3,5
FG-T68177R/L-W	755	1792	40	3,5
FG-T72177R/L-W	795	1792	40	3,5
FG-T68192R/L-W	755	1942	40	3,8
FG-T72192R/L-W	795	1942	40	3,8
FG-T62177R/L-G	695	1792	40	3,5
FG-T68177R/L-G	755	1792	40	3,5
FG-T72177R/L-G	795	1792	40	3,5
FG-T68192R/L-G	755	1942	40	3,8
FG-T72192R/L-G	795	1942	40	3,8

ADDITION FLY SCREEN FRAME				
FGR-T62177R-W	695	1792	40	2,1
FGR-T68177R-W	755	1792	40	2,1
FGR-T72177R-W	795	1792	40	2,1
FGR-T68192R-W	755	1942	40	2,1
FGR-T72192R-W	795	1942	40	2,1

Fly screen frame

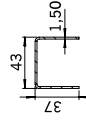
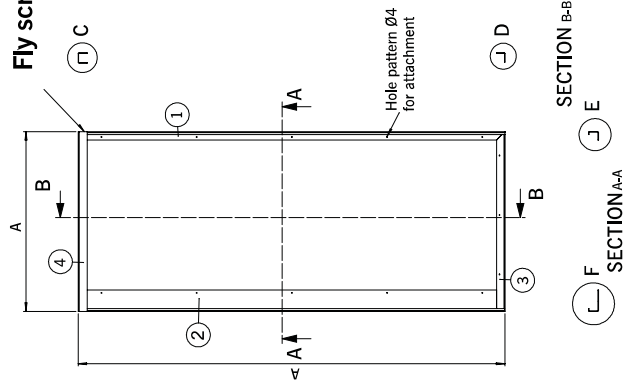

DETAIL C
SCALE 1 : 2



DETAIL E
SCALE 1 : 2



DETAIL D
SCALE 1 : 2



DETAIL F
SCALE 1 : 2